



















Practice, Learn and Achieve  
Your Goal with Prepp

# SBI Clerk Exam

Mains Answer Key

Simplifying  
Government Exams

 SSC CHSL	 IAS EXAM	 RRB NTPC	 NTSE	 CDS
 SSC CGL	 CBSE UGC NET	 IBPS PO	 NDA	
 SBI PO	 IBPS CLERK	 AFCAT	 SSC JE	 CTET
 CSIR UGC NET	 CAPF	 IBPS RRB		

[www.prepp.in](http://www.prepp.in)

## Solutions

1. Ans. A.

According to the first paragraph, "These, however, did not work as some felt that these are but band-aid solutions; instead, radical systemic reform is necessary." Band-aid solutions mean non-permanent or superficial remedies which would never reform the entire education system.

The other two statements are either inconsistent with the ideas in the passage, or have not been mentioned at all.

Hence, option A is the correct response.

2. Ans. D.

All the given suggestions (A, B and C) have been made by the author to improve the state of education in India:

A- "Well-run corporate organisations, within an appropriate regulatory framework, would be far better than the so-called trusts which-barring some noteworthy exceptions-are a blot on education."

B- "Easy Loan/scholarship arrangements would ensure affordability and access."

C- "A regulatory framework which creates competition, in tandem with a rating system, would automatically ensure the quality and relevance of education."

Hence, option D is correct.

3. Ans. B.

According to the author, creation of autonomous institutes for management and technology which were not under university control was the only step taken in order to reform the higher education:

"They were also given autonomy and freedom beyond that of the universities."

Hence, option B is correct.

4. Ans. B.

The phrase as mentioned is a metaphorical reference to the fact that the commercialisation of important aspects of life is already in the scene and thus the commercialisation of higher education is not a new phenomenon.

Hence, option B is correct.

5. Ans. E.

All the given (A, B, C and D) are true in the context of the given passage.

A- "though the law stipulates that educational institutes must be 'not-for-profit' trusts or societies"

B- "Today, unfortunately, there is no protest against selling drinking water or paying to be cured of illness, or for having to buy food when one is poor and starving."

C- "Some individuals and businessmen had entered this sector long back and found devious ways of making money."

D- " there is opposition to the entry of for-profit' corporates, which would be more transparent and accountable."

Hence, option E is correct.

6. Ans. B.

Noteworthy means worth paying attention to; interesting or significant. Thus, 'insignificant' is most opposite in meaning. Hence, option B is correct.

Obsolete- useless

7. Ans. A.

Devious means showing a skilful use of underhand tactics to achieve goals;

'dishonest' is most similar in meaning. Hence, option A is correct.

8. Ans. E.

'Promoting' means to support or actively encourage (a cause, venture, etc.); further the progress of.

'Hampering' means to obstruct the progress of something, and is the correct antonym for the question word.

9. Ans. C.

The difference is in their attitude towards change which can be inferred from the first paragraph.

10. Ans. E.

It can be inferred from the following lines of the passage, 'must have a serene confidence in their own wisdom on the one hand and the recklessness of other people's sufferings on the other, which Robespierre and St. Just, hitherto the typical instances of those united attributes, scarcely came up to.'

11. Ans. C.

Corruption in high places has not been mentioned in the passage.

12. Ans. B.

According to the passage, 'It is not so with the other (revolutionary socialism); the aim of that is to substitute the new rule for the old at a single stroke.'

13. Ans. A.

After reading the passage, we realise that the author does not sympathize with either of the two sides and is critical about both of them.

14. Ans. A.

Avow- declare, proclaim

Proclaim- declare, announce

Censure- condemnation, criticism

Reclaim- recover

Repudiate- reject

Abjure- reject

Thus, option A is the correct answer.

15. Ans. D.

'Plunge' means a quick drop. Contrary to that, 'ascent' is the most suitable response. All the other words carry meanings similar to "plunge".

16. Ans. A.

'Serene' means calm, undisturbed. Corresponding to that, 'placid' is the most suitable response. The other words are antonyms.

17. Ans. B.

'Risen' is the past participle form of the verb 'rise', while we need the verb 'raise' as the usage is in the infinitive form which always takes the first form of the verb after 'to'.

18. Ans. A.

The highlighted segment in the above context has an error of preposition. Instead of using "for developers" in the segment, it should be "with developers". "For" is used with a period of time to express the duration or 'how long' something has happened. "With" is used to add something in a given context to provide extra information. Hence A is grammatically correct.

19. Ans. C.

In the given statement a tense verb disagreement occurs if we use the word "fulfilled" as the verb in the latter part of the statement is in simple present tense. However, if the word "fulfilling" is used, the sentence becomes correct.

20. Ans. B.

The use of the preposition 'of' is superficial in the boldened part and it needs to be omitted to make the sentence grammatically correct.

21. Ans. D.

There are several errors in the given sentence. the infinitive "to" cannot be followed by a gerund, therefore, "to saying" is incorrect. Another mistake is in the usage of 'being' is incorrect and 'be' is correct. Out of the available alternatives, only option D considers and addresses by also replacing 'something' with 'anything'.

The correct response will be option D.

22. Ans. A.

The first blank needs an adjective that can be used to identify with the scientific community. While multiple options seem to make sense in the context of the blank, it is important to note that both the blanks need to be filled in such a way that they give almost opposite qualities to two different sets of people.

On the basis of these filters, only option A qualifies for filling the blanks and thus is the correct response.

23. Ans. D.

The sentence is about a newspaper journey of 139 years. During these years the newspaper has changed with upcoming trends by adapting and embracing the new technological changes yet it never compromised with its core value. The first word must mean 'the whole'. The second word must mean 'to accept and adapt'. Therefore, option D is apt. 'Entirety' means the whole of something and embraces means to an act of accepting something willingly or enthusiastically.

24. Ans. A.

The trick here is to look into the structure of the statement around the blanks. 'Inquiring' or 'efficient' makes no sense in context of the 'victims'; this leaves us with only two possible options, A and E. Now, if we put 'regarding' in the first blank, then the sentence makes no sense, So, the correct response is option A.

25. Ans. B.

Option A is incorrect because 'shift in efficiency' makes no sense.

Option C is incorrect because the second blank is followed by 'of', which makes 'subject' idiomatically inappropriate.

Option D is incorrect because 'power' being related to 'product' does not make any sense. 'Discourse' means 'written or spoken communication or debate'.

Option E is incorrect because of 'issue' being incorrect in the context of the statement.

26. Ans. C.

This is an easy question as it does not even require the knowledge about the exact meaning of the words. The statement considers a singular subject 'globalisation' and thus the verb associated with it should be singular as well i.e. should take a verb in '-s/es' form for the second blank. Out of the available options, only option C suits this criteria and thus is the correct response.

27. Ans. C.

Quarrelling means have an angry argument or disagreement.

Squandering means to waste (something, especially money or time) in a reckless and foolish manner.

Battling means struggle tenaciously to achieve or resist something.

Squatting means unlawfully occupy an uninhabited building or settle on a piece of land.

The context here is of the people of Chennai trying to fight the issues caused by rain and thus a synonym of 'struggling' needs to be used. Thus, 'Battling' is the correct response.

28. Ans. A.

The context is of seeking shelter under some camps organized for those stranded in rain. 'Taking refuge' is a phrase that represents this and thus option A is the correct response.

29. Ans. B.

Surrounded means be all round (someone or something).

Grounded means to be in immobile condition.

Zeroed means to pay attention: concentrate, focus.

Flooded means fill or suffuse completely. fill or suffuse completely.

Evacuated means remove (someone) from a place of danger to a safer place.

The reference is of the vehicles not being able to move because of the flood and thus option B is the correct response.

30. Ans. D.

The context here is of the public transport being completely filled with passengers and thus 'packed' is the most appropriate response.

31. Ans. B.

The context here is of damages caused due to the excess rain and thus 'suffered' shall be the most appropriate response in this regard.

32. Ans. A.

The context is of getting extra rain.

Option B is incorrect because it gives the idea that the districts in question are providing the rain, which is incorrect.

Option C is incorrect as rain is something which can't be achieved.

Option D is incorrect as the rain caused damages and thus 'gained' will make no sense.

Option E is incorrect as 'levied' is generally used in the monetary context, which is not the case here.

So,, the correct response is option A.

33. Ans. C.

Curiously means in a way that shows eagerness to know or learn something.

Suitably means in a way that is right or appropriate for a particular purpose or situation.

Alarmingly means in a worrying or disturbing way.

Seriously means in a solemn or considered manner.

Nearly means very close to; almost.

The idea conveyed here is of an extreme climatic situation, thus, "alarmingly" is the best-fit word.

34. Ans. E.

The tense needs to be simple past as the statement is about an action that has taken place in the past.

This leaves only options D and E as the possible choices. Now, when talking about whether we use the verb 'forecasted' or 'predicted'.

Thus, option E is the most appropriate response.

35. Ans. D.

The tense of the statement is present perfect and thus the third form of the verb needs to be used.

Out of the available options, only option D is in third form and thus is the correct response.

36. Ans. A.

The context here is of the government way of response to the disaster and thus it is very obvious that the required trait will be how promptly and quickly can the authorities respond. Thus option A is the correct response.

37. Ans. D.

Refer to the last question of the series.

38. Ans. A.

Refer to the last question of the series.

39. Ans. E.

Refer to the last question of the series.

40. Ans. C.

A is invariably the first statement as it opens the discussion by introducing the decision taken by RBI. C is the next statement as it begins to talk about one particular entity, about which most of the latter discussions are about. C mentions the application of the the final license, and G reports the same thing as stated by the executive vice president of the concerned company. G and B form a mandatory pair as these statements contain the information from one particular individual. E follows B because another important entity in the concerned company is talked about. E and F also form a mandatory pair as both of them talk about K Paul Thomas. The word 'lender' in F refers to him. D is the last sentence as it talks about two other companies which haven't been mentioned so far. Thus, the correct sequence after rearrangement is ACGBEFD.

41. Ans. B.

$$7 \times 1 + 5 = 12$$

$$12 \times 2 + 5 = 29$$

$$29 \times 3 + 5 = 92$$

$$92 \times 4 + 5 = 373$$

$$373 \times 5 + 5 = 1870$$

42. Ans. C.

$$+1^3, -2^3, +3^3, -4^3, +5^3$$

43. Ans. A.

$$*2-2, *3+3, *4-4, *5+5$$

44. Ans. D.

The series is 15+6, 21+18, 39+38, 77+66, 143+102.

The inner series is 6+12, 18+20, 38+28, 66+36.

Again the inner series is 12+8, 20+8, 28+8.

45. Ans. C.

$$5,$$

$$8 = 5 + 2^2 - 1,$$

$$16 = 8 + 3^2 - 1,$$

$$31 = 16 + 4^2 - 1,$$

$$55 = 31 + 5^2 - 1,$$

$$\text{Next number} = 55 + 6^2 - 1 = 90$$

46. Ans. D.

$$\frac{30}{v+x} + \frac{30}{v-x} = 8$$

$$\frac{30}{v+x} + \frac{30}{v-x} = 8$$

Where v and x are speed of the boat and water current respectively.

$$V = 4x$$

$$\frac{30}{5x} + \frac{30}{3x} = 8$$

$$\frac{6}{x} + \frac{10}{x} = 8$$

$$x + x = 8$$

$$X = 2 \text{ kmph}$$

47. Ans. C.

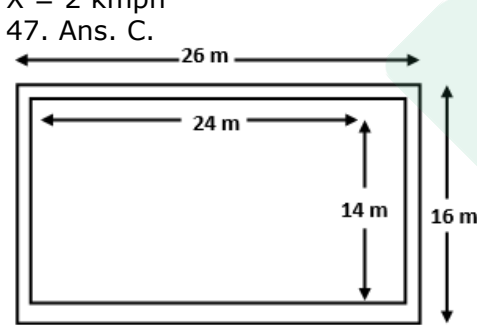

$$\text{Area of garden} = 24 \times 14 = 336 \text{ m}^2$$

$$\text{Area of the (garden + path)} = 26 \times 16 = 416 \text{ m}^2$$

$$\text{Area of the path} = 416 - 336 = 80 \text{ m}^2$$

$$\text{Area of 1 tile} = 20 \times 20 = 400 \text{ cm}^2 = 0.04 \text{ m}^2$$

$$\text{Number of tiles required} = 80/0.04 = 2000.$$

48. Ans. B.

$$SQ^2 = 8^2 + 6^2$$

$$= 64 + 36$$

$$= 100$$

$$QR^2 = SQ^2 + SR^2$$

$$QR^2 = 100 + 24^2$$

$$QR^2 = 100 + 576$$

$$QR = \sqrt{676}$$

$$= 26$$

49. Ans. C.

Let the investments of P, Q and R be 5x, 6x and 8x respectively

Total equivalent capital of P

$$= 5x \times 12 + 8x \times 12$$

$$= 60x + 96x = \text{Rs. } 156x$$

Total equivalent capital of Q

$$= 6x \times 24 = 144x$$

Total equivalent capital of R

$$= 8x \times 12 + 4x \times 12$$

$$= 96x + 48x = \text{Rs. } 144x$$

Required earned profit ratio

$$= 156x : 144x : 144x$$

$$= 13 : 12 : 12$$

50. Ans. A.

Let Mr Ram monthly income be Rs. 100

Then, money spent on household expenditure

$$= 100 \times 20/100 = \text{Rs. } 20$$

$$\text{Remaining amount} = 100 - 20 = \text{Rs. } 80$$

Money spent on children's education =

$$80 \times \frac{25}{100} = \text{Rs } 20$$

Money spent on transport = 80 X 15/100 = Rs. 12

Money spent on medicine = 80 x 15/100 = Rs. 12

Money spent on entertainment = 80X10/100=Rs. 8

Last remaining amount = 100 -(20 + 20 + 12 + 12 + 8)

$$= 100 - 72 = \text{Rs. } 28$$

Now, Rs. 28 is left, when total income is Rs. 100

Rs. 1 is left, when total income = 100/28

Rs. 9800 is left, when total income

$$= 100/28 \times 5600$$

$$= \text{Rs. } 20000$$

51. Ans. A.

Total marker = 12

$$n(S) = {}^{12}C_4 = 12!/(4! \times 8!) = 5 \times 99$$

n(E1) = out of 5 marker, no. of ways to not pick

$$\text{Green marker} = {}^5C_0 = 1$$

n(E2) = out of 7 marker, no. of ways to pick 4

$$\text{markers} = {}^7C_4 = 35$$

$$p(E) = \frac{n(E1) n(E2)}{n(S)} = \frac{1 \times 35}{5 \times 99} = \frac{7}{99}$$

52. Ans. C.

$$6x^2 + 9x + 22x + 33 = 0$$

$$3x(2x + 3) + 11(2x + 3) = 0$$

$$(2x + 3)(3x + 11) = 0$$

$$x = -11/3, -3/2$$

$$y^2 - 19y - 13y + 247 = 0$$

$$y(y - 19) - 13(y - 19) = 0$$

$$(y - 19)(y - 13) = 0$$

$$y = 19, 13$$

53. Ans. C.

$$3x^2 + 6x + 7x + 14 = 0$$

$$3x(x + 2) + 7(x + 2) = 0$$

$$(x + 2)(3x + 7) = 0$$

$$x = -2, -7/3$$

$$8y^2 + 14y + 12y + 21 = 0$$

$$2y(4y + 7) + 3(4y + 7) = 0$$

$$(2y + 3)(4y + 7) = 0$$

$$y = -3/2, -7/4$$

54. Ans. E.

$$2x^2 - 19x + 44 = 0$$

$$2x^2 - 11x - 8x + 44 = 0$$

$$x(2x - 11) - 4(2x - 11) = 0$$

$$(x - 4)(2x - 11) = 0$$

$$x - 4 = 0 \text{ or } 2x - 11 = 0$$

$$x - 4 = 0 \text{ or } 2x = 11$$

$$x = 4 \text{ or } x = 11/2$$

$$x = 4 \text{ or } x = 5.5$$

$$2y^2 - 21y + 52 = 0$$

$$2y^2 - 8y - 13y + 52 = 0$$

$$2y(y - 4) - 13(y - 4) = 0$$

$$(y - 4)(2y - 13) = 0$$

$$y - 4 = 0 \text{ or } 2y - 13 = 0$$

$$y = 4 \text{ or } 2y = 13$$

$$y = 4 \text{ or } y = 13/2$$

$$y = 4 \text{ or } y = 6.5$$

Relationship cannot be established

55. Ans. A.

$$x = -2/3, 4$$

$$y = -6, -9/2$$

Put all values on number line and analyze the relationship

$$-6 \dots -9/2 \dots -2/3 \dots 4$$

56. Ans. A.

$$4x + 3y = 40$$

$$6x - 5y = 22$$

By solving the two equations we get

$$x = 7, y = 4$$

57. Ans. E.

Bank	Number of visitors in week ( x100)	Average (Total/7)
Peoples	125	18
Welfare	105	15
United	135	19

We don't have to calculate the average per se as we can just find the maximum visitors amongst the 3 banks, since the denominator for all is 7.

58. Ans. D.

If we just find the percentage rise for each option, we can find the right answer:

$$\text{Option 1 - Friday, United bank} = [(35 - 20)/20] * 100 = 75\%$$

$$\text{Option 2 - Wednesday, Welfare bank} = [(35 - 20)/20] * 100 = 75\%$$

$$\text{Option 3 - Wednesday, Peoples bank} = [(35 - 25)/25] * 100 = 40\%$$

$$\text{Option 4 - Tuesday, Welfare bank} = [(20 - 10)/10] * 100 = 100\%$$

$$\text{Option 5 - Tuesday, Peoples bank} = [(25 - 20)/20] * 100 = 25\%$$

59. Ans. A.

Number of visitors who stopped coming to United bank = 10% of total United visitors in a week = 10% of 13500 = 1350

Number of visitors who stopped coming to Welfare bank = 15% of total Welfare visitors in a week = 15% of 10500 = 1575

$$\text{Percentage} = (1350/1575) * 100 = 85\%$$

60. Ans. B.

We can find average time per customer for all days of all banks, but we can narrow it down and find the average time per customer of the 5 options-

$$\text{Option 1 - Welfare bank, Wednesday} - 105/35 = 3\text{h}/100 \text{ customers}$$

$$\text{Option 2 - United bank, Wednesday} - 25/25 = 1\text{h}/100 \text{ customers}$$

$$\text{Option 3 - Peoples bank, Thursday} - 45/30 = 1.5\text{h}/100 \text{ customers}$$

$$\text{Option 4 - Welfare bank, Tuesday} - 30/20 = 1.5\text{h}/100 \text{ customers}$$

$$\text{Option 5 - United bank, Monday} - 45/30 = 1.5\text{h}/100 \text{ customers}$$

Therefore, United bank, on Wednesday, is the most efficient bank.

61. Ans. A.

$$\text{Number of deposit slips used in Peoples bank on Monday, Tuesday and Wednesday combined} = (20 + 25 + 35) * 60 = 4800$$

$$\text{Number of deposit slips used in United bank on Thursday and Friday combined} = (20 + 35) * 40 = 2200$$

$$\text{Required ratio} = 4800/2200 = 24/11$$

62. Ans. E.

We cannot get the answer even from the statements I and II together,

We cannot form a solvable equation with the help of I and II, as data is not sufficient.

63. Ans. D.

Given that, Train 'A' running at a certain speed crosses another train 'B' running at a certain speed in the opposite direction in 24 seconds. A train crosses another train running in opposite direction when the whole length of the train crosses the other train.

From first statement,

Length of both train is given but until we don't have information about length of Train A or speed of both trains, we cannot calculate length of train B.

Thus, the data in statement I alone are not sufficient to answer the question.

From second statement,

In this statement, there is no information about speed of trains. So, just the knowledge that, train 'A' is slower than train 'B' is not enough to reach at the solution.

Combining both statements,

Even on combining both statements, we don't have enough data to calculate the speed of trains.

64. Ans. D.

$${}^4C_1 \times {}^3C_1 \times {}^2C_2 = 12$$

65. Ans. D.

From 1 we can get the sum of present age of the family members

From 2 we can get sum of ages of the couple so answer is (D)

66. Ans. D.

Cost of fencing per square meter is not given. So, even combined both the statements together, total cost of fencing can't be determined.

67. Ans. A.

Let tap C will empty the tank in 't' minutes

Here, X = 30, Y = 60 and Total time to fill tank = 50 minutes

C can empty the full tank in = 50 Minutes

$$= (1/30 + 1/60 - 1/t) = 1/50$$

$$1/30 + 1/60 - 1/50 = 1/t$$

$$T = 100/3 \text{ minutes}$$

$$= 33.33 \text{ minutes}$$

68. Ans. A.

Given that CPs are in the ratio 1:2

Therefore let the CPs be Rs.100 & Rs. 200 respectively,

$$1^{\text{st}} \text{ SP} = 100 - 15\% \text{ of } 100 = \text{Rs. } 85.$$

$$2^{\text{nd}} \text{ SP} = 200 + 10\% \text{ of } 200 = \text{Rs. } 220.$$

$$\text{Total CP} = \text{Rs.}300. \text{ Total SP} = 85 + 220 = \text{Rs.}305.$$

$$\text{Profit} = \text{Rs.}305 - 300 = \text{Rs.}5.$$

$$\text{Profit percent} = 5 * 100 / 300 = 1.66\% \text{ profit.}$$

69. Ans. B.

Let the number of days A can finish be x

$$B = 2x$$

So,

$$1/x + 1/2x = 1/10$$

$$2 + 1/2x = 1/10$$

$$2x = 30$$

$$x = 15 \text{ days}$$

$$A = 15 \text{ days}$$

$$B = 30 \text{ days}$$

$$\text{Total units of work} = 30 \text{ units}$$

$$A's \text{ one day work} = 2 \text{ units}$$

$$B's \text{ one day work} = 1 \text{ unit}$$

$$\text{Work done in 2 days} = 2 + 1 = 3 \text{ units}$$

$$\text{Work done in 20 days} = 3 * 10 = 30 \text{ units}$$

$$\text{Work will be completed in 20 days.}$$

70. Ans. A.

$$2\pi r = 88$$

$$r = \frac{44 \times 7}{22} = 14$$

$$\text{Area of triangle} = \frac{1}{2} \sqrt{2}r \cdot \sqrt{2}r = r^2$$

$$= 14^2 = 196$$

71. Ans. B.

$$\text{Area} = \pi(20)^2 - (\pi(10)^2 + \pi(10)^2)$$

$$= 400\pi - 200\pi$$

$$= 200\pi$$

72. Ans. C.

First find out the total number of rotten plums with

$$\text{Shopkeeper M} = 200 * 20 / 100 = 40$$

$$\text{Shopkeeper N} = 250 * 30 / 100 = 75$$

$$\text{Shopkeeper O} = 160 * 15 / 100 = 24$$

$$\text{Shopkeeper P} = 300 * 16.66 / 100 = 50$$

$$\text{Shopkeeper Q} = 180 * 10 / 100 = 18$$

$$\text{Total number of plums spoiled} = 207$$

73. Ans. D.

Unspoiled guava with shopkeepers

$$M = 600 * 90\% = 540$$

$$N = 800 * 80\% = 640$$

$$O = 1000 * 65\% = 650$$

$$P = 1200 * 83.33\% = 1000$$

$$Q = 900 * 80\% = 720$$

Hence, P has the highest number of unspoiled bananas

74. Ans. A.

Weight of kiwi with

$$M = 150 * 60 = 9000 \text{ gm,}$$

$$N = 100 * 75 = 7500 \text{ gm}$$

$$O = 80 * 50 = 4000 \text{ gm}$$

$$P = 200 * 100 = 20000 \text{ gm}$$

$$Q = 240 * 90 = 21600 \text{ gm}$$

$$\text{Hence, total weight of all kiwi} = 62.1 \text{ kg}$$

75. Ans. B.

$$\text{Unspoiled kiwi with E} = 240 * 75 / 100 = 180$$

$$\text{Spoiled guava with C} = 1000 * 35 / 100 = 350$$

$$\text{Required percentage} = 350 - 180 / 350 = 48.57\%$$

76. Ans. D.

$$\text{Weight of kiwi with M, N, O} = 20.5 \text{ kg}$$

$$\text{Weight of guava with vendors M, N, O, P, Q} = 234.6 \text{ kg}$$

$$\text{Required \%} = 20.5 / 234.6 \% = 8.73\%$$

So Answer 9% approx.

77. Ans. C.

It is given that average weight of 20 girls is 25 kg, let the teacher's weight is X kg

$$25 = \frac{\text{Sum of the weights of 20 girls}}{20}$$

Sum of the weights of 20 girls = 500 kg

$$25 + 2 = \frac{500 + X}{21}$$

$$X = 67 \text{ kg}$$

Hence (III) is the correct answer.

78. Ans. B.

$$992.25 = 14000 \left(\frac{r}{100}\right)^2 (300 + \frac{r}{100})$$

$$567/8 = r^2 (300 + r/1000)$$

$$\text{Or, } 70875 = r^2 (300 + r)$$

By moving through options we find that  $r = 15\%$  will satisfy the above equation.

79. Ans. D.

$$\text{No. of ways when none is women} = {}^4C_3 = 4$$

$$\text{Total possible way} = {}^9C_3 = 84$$

$$\text{Required ways} = 84 - 4 = 80$$

80. Ans. B.

In time work we all know that, more man power means less time.

M = men

W = women

$$3m + 7w = 12 \text{ ----(i)}$$

$$7m + 3w = 8 \text{ -----(ii)}$$

The two equations will be equal after some manipulations.

$$1/4 (3m + 7w) = 48 = 1/6 (7m + 3w)$$

$$\Rightarrow 18m + 42w = 28m + 12w$$

$$\Rightarrow 10m = 30w$$

$$\Rightarrow 1m = 3w$$

Now putting this into equation (i),

$$3*3w + 7w = 12$$

$$\Rightarrow 16w = 12$$

$$\Rightarrow 1w = 192$$

$$\text{Therefore, 3 women will take} = 192/3 = 64 \text{ days}$$

81. Ans. A.

The trains need to travel 15 min. extra @ 35 Kmph so it is behind by 8.75 Km .

Rate of losing distance is 5 Kmph hence the train must be travelled for  $8.75/5 = 1 \text{ Hour } 45 \text{ minutes}$  @ 40 kmph  $\rightarrow 70 \text{ Km}$

40 kmph  $\rightarrow 70 \text{ Km}$

**Alternative Approach:**

**Since distance is constant, therefore**

$$s_1/s_2 = t_2/t_1$$

**$40/35 = t - 15/t$  where t is time taken to reach on time.**

$$t = 105 \text{ min} = 105/60 \text{ hours}$$

$$\text{Total distance} = s_1 * t_1 = 40 * 105/60 = 70 \text{ km}$$

82. Ans. D.

In the given mixture of 80 litres, water is 20% hence, water is 16 litres and Alcohol is 64 litres.

Let X litres of water should be added in the mixture.

Alcohol	Water
64 litres	16 litres
64 litres	16 + X litres

Now water becomes  $23\frac{17}{21}\%$  of the mixture

$$\frac{16 + X}{64 + 16 + X} \times 100 = \frac{500}{21}$$

By solving this we get  $X = 4$  litres.

83. Ans. B.

Rate of filling a cistern with pipe X =  $1/24$

Rate of filling a cistern with pipe Y =  $1/32$

Given: If both the pipes are opened together and after some time pipe Y has closed.

Let pipe Y is closed after x minutes.

Therefore part of cistern filled with pipes X and Y

$$18/24 + x/32 = 1$$

$$1/4 = x/32$$

$$\Rightarrow x = 8 \text{ minutes}$$

84. Ans. C.

suppose the ages of father and son are 5x yr and 2x yr

After four years, the age of son =  $(2x + 4)$  yr

After four years, the age of mother =  $(4x + 8)$  yr

So, the present age of mother =  $(4x + 4)$  yr

Ratio of the age of father and mother =  $5x : 4x + 4$

Since, data is insufficient, so cannot be determined.

85. Ans. A.

let, men = M, women = W , Youngster = Y

$$\text{Then } 2M = 3W = 4Y$$

$$W = 2/3 M \text{ and } Y = 1/2 M$$

$$\text{Given } 14M + 12W + 12Y$$

$$14 + 2/3 \times 12 + 1/2 \times 12$$

$$28 \text{ men}$$

$$28 \times 24 = m \times 14 = m = 48$$

$$\text{Therefore, additional labour} = 48 - 28 = 20$$

86. Ans. A.

Let the length be X

Then breadth be  $X/2$

$$\text{Now, } X * X/2 = 972/6 = 162$$

$$X^2 = 162 * 2$$

$$X = 18$$

$$\text{Again, perimeter of circle} = 18 * 22$$

So,

$$2\pi r = 18 * 22$$

$$2 * (22/7) * r = 18 * 22$$

$$r = 63$$

$$\text{Area of circle} = \pi r^2 = 22/7 * (63 * 63) = 12474 \text{ sq m}$$



87. Ans. B.

Let the total students be x

So,

$$20/100 * 70x/100 + 10/100 * 30x/100 = 1700$$

$$14x/100 + 3x/100 = 1700$$

$$17x = 170000$$

$$x = 10000$$

Number of students not getting fee exemption =

$$10000 - 1700 = 8300$$

Number of student getting 75% exemption =

$$40 * 8300 / 100 = 3320$$

88. Ans. D.

A takes 1 hour after meeting and B takes 4 hours after meeting. Hence Time traveled before meeting =  $v \cdot 1.4 = 2$  hours Time taken by A =  $2 + 1 = 3$  hours

**Analysis**  
It can be shown diagrammatically below

As the Distances covered are the same, the Time ratios are equal  
i.e.  $\frac{t}{4} = \frac{1}{t}$ . i.e.  $t = 2$  hrs. Thus A will take  $2 + 1 = 3$  hours

89. Ans. C.

Let the common ratio be Rs x.

Therefore X's salary = Rs 6x and Y's salary = Rs 5x

$$\frac{6x \times 125\%}{5x \times 115\%} = \frac{750}{575} = \frac{30}{23}$$

$$\frac{6x \times 125\%}{5x \times 115\%} = \frac{750}{575} = \frac{30}{23}$$

Thus the required ratio is 30 : 23.

90. Ans. D.

Given, car and bike dealer bought 30 second hand cars and bikes for Rs. 472500.

He bought eight cars and rest of them were bikes.

Let the selling price of each car be 'a'

Given, he made a profit of 40% by selling them.

$$\Rightarrow 8a + (3a/4) \times 22 = 472500 + 40\% \text{ of } 472500$$

$$\Rightarrow 49a/2 = 1.4 \times 472500$$

$$\Rightarrow a = \text{Rs. } 27000$$

91. Ans. E.

(i) Hemant lives on the 5<sup>th</sup> floor and there are two people live between Hemant and Chetan. Hemant is going to Chennai.

Chetan		8
		7
		6
Hemant	Chennai	5
		4
		3
		2
		1

**1<sup>st</sup> possibility**

		8
		7
		6
Hemant	Chennai	5
		4
		3
Chetan		2
		1

**2<sup>nd</sup> possibility**

(ii) Elena lives on an odd numbered floor but not the first floor and is not an immediate neighbour of Chetan or Hemant. Fatima lives second to the floor of Elena.

Chetan		8
		7
		6
Hemant	Chennai	5
		4
Elena		3
		2
Fatima		1

(iii) Three people lives between Hemant and the one who visits to Pune. Hemant, Chetan and also the immediate neighbours do not visit to Mumbai. Only one person lives between the one who visits to Mumbai and Gauri. The one who visits to Delhi is an immediate neighbour of Elena. The one who visits to Kolkata and Lucknow are immediate neighbours of each other. Chetan neither visits to Kolkata nor to Lucknow. Only one person lives between Arun and the one who visits to Punjab. Arun neither visits to Mumbai nor to Kolkata. Bhavna does not visit to Mumbai.

Chetan	Punjab	8
Bhavna	Kolkata	7
Arun	Lucknow	6
Hemant	Chennai	5
Gauri	Delhi	4
Elena	Rajasthan	3
Diksha	Mumbai	2
Fatima	Pune	1

### Final Arrangement

92. Ans. D.

(i) Hemant lives on the 5<sup>th</sup> floor and there are two people live between Hemant and Chetan. Hemant is going to Chennai.

Chetan		8
		7
		6
Hemant	Chennai	5
		4
		3
		2
		1

#### 1<sup>st</sup> possibility

		8
		7
		6
Hemant	Chennai	5
		4
		3
Chetan		2
		1

#### 2<sup>nd</sup> possibility

(ii) Elena lives on an odd numbered floor but not the first floor and is not an immediate neighbour of Chetan or Hemant. Fatima lives second to the floor of Elena.

Chetan		8
		7
		6
Hemant	Chennai	5
		4
Elena		3
		2
Fatima		1

(iii) Three people lives between Hemant and the one who visits to Pune. Hemant, Chetan and also the immediate neighbours do not visit to Mumbai. Only one person lives between the one who visits to Mumbai and Gauri. The one who visits to Delhi is an immediate neighbour of Elena. The one who visits to Kolkata and Lucknow are immediate neighbours of each other. Chetan neither visits to Kolkata nor to Lucknow. Only one person lives between Arun and the one who visits to Punjab. Arun neither visits to Mumbai nor to Kolkata. Bhavna does not visit to Mumbai.

Chetan	Punjab	8
Bhavna	Kolkata	7
Arun	Lucknow	6
Hemant	Chennai	5
Gauri	Delhi	4
Elena	Rajasthan	3
Diksha	Mumbai	2
Fatima	Pune	1

### Final Arrangement

93. Ans. C.

(i) Hemant lives on the 5<sup>th</sup> floor and there are two people live between Hemant and Chetan. Hemant is going to Chennai.

Chetan		8
		7
		6
Hemant	Chennai	5
		4
		3
		2
		1

#### 1<sup>st</sup> possibility

		8
		7
		6
Hemant	Chennai	5
		4
		3
Chetan		2
		1

#### 2<sup>nd</sup> possibility

(ii) Elena lives on an odd numbered floor but not the first floor and is not an immediate neighbour of Chetan or Hemant. Fatima lives second to the floor of Elena.

Chetan		8
		7
		6
Hemant	Chennai	5
		4
Elena		3
		2
Fatima		1

(iii) Three people live between Hemant and the one who visits to Pune. Hemant, Chetan and also the immediate neighbours do not visit to Mumbai. Only one person lives between the one who visits to Mumbai and Gauri. The one who visits to Delhi is an immediate neighbour of Elena. The one who visits to Kolkata and Lucknow are immediate neighbours of each other. Chetan neither visits to Kolkata nor to Lucknow. Only one person lives between Arun and the one who visits to Punjab. Arun neither visits to Mumbai nor to Kolkata. Bhavna does not visit to Mumbai.

Chetan	Punjab	8
Bhavna	Kolkata	7
Arun	Lucknow	6
Hemant	Chennai	5
Gauri	Delhi	4
Elena	Rajasthan	3
Diksha	Mumbai	2
Fatima	Pune	1

**Final Arrangement**

94. Ans. B.

(i) Hemant lives on the 5<sup>th</sup> floor and there are two people live between Hemant and Chetan. Hemant is going to Chennai.

Chetan		8
		7
		6
Hemant	Chennai	5
		4
		3
		2
		1

**1<sup>st</sup> possibility**

		8
		7
		6
Hemant	Chennai	5
		4
		3
Chetan		2
		1

**2<sup>nd</sup> possibility**

(ii) Elena lives on an odd numbered floor but not the first floor and is not an immediate neighbour of Chetan or Hemant. Fatima lives second to the floor of Elena.

Chetan		8
		7
		6
Hemant	Chennai	5
		4
Elena		3
		2
Fatima		1

(iii) Three people live between Hemant and the one who visits to Pune. Hemant, Chetan and also the immediate neighbours do not visit to Mumbai. Only one person lives between the one who visits to Mumbai and Gauri. The one who visits to Delhi is an immediate neighbour of Elena. The one who visits to Kolkata and Lucknow are immediate neighbours of each other. Chetan neither visits to Kolkata nor to Lucknow. Only one person lives between Arun and the one who visits to Punjab. Arun neither visits to Mumbai nor to Kolkata. Bhavna does not visit to Mumbai.

Chetan	Punjab	8
Bhavna	Kolkata	7
Arun	Lucknow	6
Hemant	Chennai	5
Gauri	Delhi	4
Elena	Rajasthan	3
Diksha	Mumbai	2
Fatima	Pune	1

**Final Arrangement**

95. Ans. C.

(i) Hemant lives on the 5<sup>th</sup> floor and there are two people live between Hemant and Chetan. Hemant is going to Chennai.

Chetan		8
		7
		6
Hemant	Chennai	5
		4
		3
		2
		1

**1<sup>st</sup> possibility**

		8
		7
		6
Hemant	Chennai	5
		4
		3
Chetan		2
		1

**2<sup>nd</sup> possibility**

(ii) Elena lives on an odd numbered floor but not the first floor and is not an immediate neighbour of Chetan or Hemant. Fatima lives second to the floor of Elena.

Chetan		8
		7
		6
Hemant	Chennai	5
		4
Elena		3
		2
Fatima		1

(iii) Three people lives between Hemant and the one who visits to Pune. Hemant, Chetan and also the immediate neighbours do not visit to Mumbai. Only one person lives between the one who visits to Mumbai and Gauri. The one who visits to Delhi is an immediate neighbour of Elena. The one who visits to Kolkata and Lucknow are immediate neighbours of each other. Chetan neither visits to Kolkata nor to Lucknow. Only one person lives between Arun and the one who visits to Punjab. Arun neither visits to Mumbai nor to Kolkata. Bhavna does not visit to Mumbai.

Chetan	Punjab	8
Bhavna	Kolkata	7
Arun	Lucknow	6
Hemant	Chennai	5
Gauri	Delhi	4
Elena	Rajasthan	3
Diksha	Mumbai	2
Fatima	Pune	1

**Final Arrangement**

96. Ans. C.

R is on the immediate right of S

L	S	R	P	O	Q	M	N
South	North	North	South	North	South	North	South

97. Ans. A.

P sits third to the left of L

L	S	R	P	O	Q	M	N
South	North	North	South	North	South	North	South

98. Ans. B.

Three persons are there between P and N

L	S	R	P	O	Q	M	N
South	North	North	South	North	South	North	South

99. Ans. A.

L & P is the one that does not belong to the group because they are facing on the same side but all other pairs of people facing on their opposite side.

L	S	R	P	O	Q	M	N
South	North	North	South	North	South	North	South

100. Ans. D.

L & N sit at the extreme ends of the line

L	S	R	P	O	Q	M	N
South	North	North	South	North	South	North	South

101. Ans. D.



Hence Option D is correct

102. Ans. E.



Hence Option E is correct

103. Ans. A.

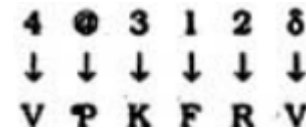

Condition (1) is applicable.

Hence Option A is correct

104. Ans. C.

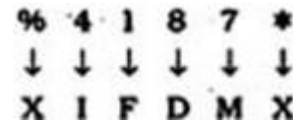

Condition (3) is applicable

Hence Option C is correct

105. Ans. B.

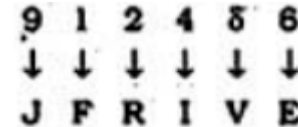

Condition (2) is applicable.

Hence Option B is correct

106. Ans. B.

$\% \Rightarrow \geq$	$\star \Rightarrow <$	$\delta \Rightarrow >$
$\S \Rightarrow =$	$\Theta \Rightarrow \leq$	

$D = T \geq M < J$

Conclusions:

I.  $J > D \Rightarrow$  Not true

II.  $M \leq D \Rightarrow$  True

Hence Option B is correct

107. Ans. C.

$\% \Rightarrow \geq$	$\star \Rightarrow <$	$\delta \Rightarrow >$
$\S \Rightarrow =$	$\Theta \Rightarrow \leq$	

$B < K = N \geq R$

Conclusions:

I.  $R = K$  ( Not true)

II.  $R < K$  ( Not true)

It is either smaller than or equal to it. Thus it is a complementary pair.

Hence Option C is correct

108. Ans. A.

$\% \Rightarrow \geq$	$\star \Rightarrow <$	$\delta \Rightarrow >$
$\S \Rightarrow =$	$\Theta \Rightarrow \leq$	

$H \geq F < W = E$

Conclusions:

I.  $E > F \Rightarrow$  True

II.  $H > W \Rightarrow$  Not true

Hence Option A is correct

109. Ans. D.

$\% \Rightarrow \geq$	$\star \Rightarrow <$	$\delta \Rightarrow >$
$\S \Rightarrow =$	$\Theta \Rightarrow \leq$	

$Z > D \leq K > M$

Conclusions:

I.  $M < D \Rightarrow$  Not true

II.  $Z > K \Rightarrow$  Not true

Hence Option D is correct

110. Ans. E.

$\% \Rightarrow \geq$	$\star \Rightarrow <$	$\delta \Rightarrow >$
$\S \Rightarrow =$	$\Theta \Rightarrow \leq$	

$W \leq B < N \leq F$

Conclusions:

I.  $F > B \Rightarrow$  True

II.  $W < N \Rightarrow$  True

Hence Option E is correct

111. Ans. D.

From I: rain is always good  $\rightarrow 5\ 3\ 9\ 7$

From II: he is always there  $\rightarrow 3\ 6\ 8\ 5$

Combining I and II, is always  $\rightarrow 3\ 5$

Thus, we can't find the exact code for 'always'.

Therefore, both I and II together are not sufficient.

112. Ans. E.

From I + II = p sit to the immediate right of T.

113. Ans. C.

**From I.**  $L > G > I, K; L > H, J$

Thus, L is the heaviest.

Thus only I is sufficient.

**From II.** In ascending order

$\_, \_, I, G, H, L$

Thus, L is the heaviest.

Therefore only II is sufficient.

114. Ans. A.

From Statement I

Scenario I	Floor No.	Scenario II
	6 <sup>th</sup>	Ishika
Gaurav	5 <sup>th</sup>	
	4 <sup>th</sup>	
	3 <sup>rd</sup>	Gaurav
Ishika	2 <sup>nd</sup>	
Kumar	1 <sup>st</sup>	Kumar

In both the scenarios, Kumar is at the ground floor.

From Statement II

Scenario I	Floor No.	Scenario II
Love	6 <sup>th</sup>	
Jagan	5 <sup>th</sup>	Love
	4 <sup>th</sup>	
Hemant	3 <sup>rd</sup>	Jagan
	2 <sup>nd</sup>	Hemant
	1 <sup>st</sup>	

We can't know who lives on the ground floor with the help of statement II.

115. Ans. D.

From Statement I

Either Neha or Abhay is sitting at one of the ends.

Abhay is third to the left of Neha. Deepak is fourth to the left of Poorvi. The possible scenarios can be

I. Deepak \_ Abhay \_ Poorvi Neha

II. Abhay Deepak \_ Neha \_ Poorvi

So, we can't find who are sitting at the extreme ends.

From Statement II

Abhay \_ Poorvi or Poorvi \_ Abhay and neither of them is sitting at the ends.

The possible scenarios can be

I. Manik Abhay \_ Poorvi Neha

II. Poorvi Neha \_ Abhay Manik

So, we can't find who are at the extreme ends.

From Statements I and II

The only possible scenario is Deepak Manik Abhay Hitesh Poorvi Neha.

Thus, Deepak and Neha are sitting at the extreme ends.

116. Ans. C.

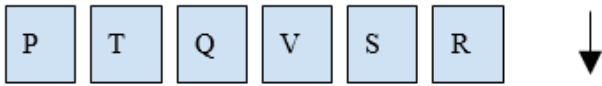

From the above diagram P and R are sitting on the extreme ends of the row.

117. Ans. E.

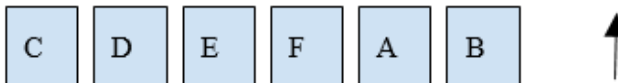
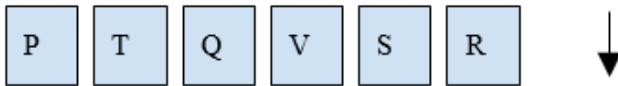

A faces S.

118. Ans. B.

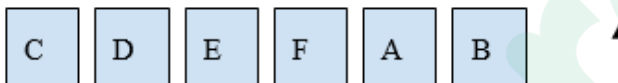
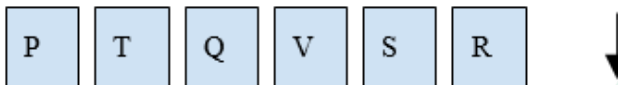

Two people are sitting in between T and S.

119. Ans. A.

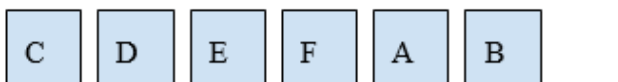
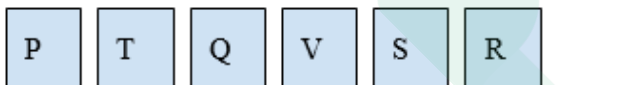

120. Ans. E.

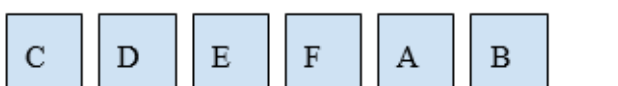
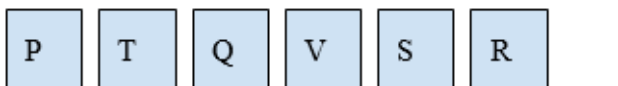

121. Ans. C.

$$\text{Area} = 480 = (2^8 \times 1) + (2^7 \times 1) + (2^6 \times 1) + (2^5 \times 1) + (2^4 \times 0) + (2^3 \times 0) + (2^2 \times 0) + (2^1 \times 0) + (2^0 \times 0) = \Delta\Delta\Delta\Delta\Delta*****$$

122. Ans. D.

$$x \times \frac{120}{100} x = 480$$

$$x = 20$$

$$\text{Length} = 20 \times \frac{120}{100} = 24$$

$$24 = (2^4 \times 1) + (2^3 \times 1) + (2^2 \times 0) + (2^1 \times 0) + (2^0 \times 0) = \Delta\Delta***$$

123. Ans. D.

$$x \times \frac{120}{100} x = 480$$

$$x = 20$$

$$\text{Length} = 20 \times \frac{120}{100} = 24$$

$$24 = (2^4 \times 1) + (2^3 \times 1) + (2^2 \times 0) + (2^1 \times 0) + (2^0 \times 0) = \Delta\Delta***$$

124. Ans. D.

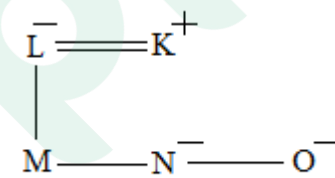

125. Ans. E.

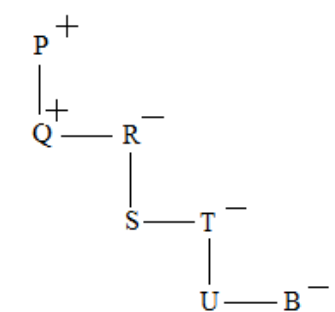

The Gender of U can't be determined so, U is either grandson or granddaughter of R.

126. Ans. B.

The family tree for option b is

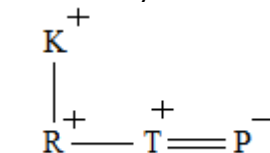

127. Ans. A.

"story" is 2<sup>nd</sup> to the left of "28" so "welcome" is 2<sup>nd</sup> to the left of "page" in step VI.

Hence, option A.

In every step one word and one number is arranged. Words are arranging in increasing order according to the alphabetical series at the left end. Numbers are arranging like that first odd numbers are arranging in each step at the right end with add 2 and then even numbers are arranging with add 6.

**Input:** story final 28 welcome 13 25 dance 11 clap 12 16 page

**Step I:** clap story final 28 welcome 13 25 dance 12 16 page 13

**Step II:** dance clap story final 28 welcome 25 12 16 page 13 15

**Step III:** final dance clap story 28 welcome 12 16 page 13 15 27

**Step IV:** page final dance clap story 28 welcome 16 13 15 27 18

**Step V:** story page final dance clap 28 welcome 13 15 27 18 22

**Step VI:** welcome story page final dance clap 13 15 27 18 22 34

128. Ans. B.

**Step IV:** page final dance clap story 28 welcome 16 13 15 27 18

$27 - 15 = 12$

Hence, option B.

In every step one word and one number is arranged. Words are arranging in increasing order according to the alphabetical series at the left end. Numbers are arranging like that first odd numbers are arranging in each step at the right end with add 2 and then even numbers are arranging with add 6.

**Input:** story final 28 welcome 13 25 dance 11 clap 12 16 page

**Step I:** clap story final 28 welcome 13 25 dance 12 16 page 13

**Step II:** dance clap story final 28 welcome 25 12 16 page 13 15

**Step III:** final dance clap story 28 welcome 12 16 page 13 15 27

**Step IV:** page final dance clap story 28 welcome 16 13 15 27 18

**Step V:** story page final dance clap 28 welcome 13 15 27 18 22

**Step VI:** welcome story page final dance clap 13 15 27 18 22 34

129. Ans. C.

**Step III:** final dance clap story 28 welcome 12 16 page 13 15 27

Hence, option C.

In every step one word and one number is arranged. Words are arranging in increasing order according to the alphabetical series at the left end. Numbers are arranging like that first odd numbers are arranging in each step at the right end with add 2 and then even numbers are arranging with add 6.

**Input:** story final 28 welcome 13 25 dance 11 clap 12 16 page

**Step I:** clap story final 28 welcome 13 25 dance 12 16 page 13

**Step II:** dance clap story final 28 welcome 25 12 16 page 13 15

**Step III:** final dance clap story 28 welcome 12 16 page 13 15 27

**Step IV:** page final dance clap story 28 welcome 16 13 15 27 18

**Step V:** story page final dance clap 28 welcome 13 15 27 18 22

**Step VI:** welcome story page final dance clap 13 15 27 18 22 34

130. Ans. B.

**Step II:** dance clap story final 28 welcome 25 12 16 page 13 15

Hence, option B.

In every step one word and one number is arranged. Words are arranging in increasing order according to the alphabetical series at the left end. Numbers are arranging like that first odd numbers are arranging in each step at the right end with add 2 and then even numbers are arranging with add 6.

**Input:** story final 28 welcome 13 25 dance 11 clap 12 16 page

**Step I:** clap story final 28 welcome 13 25 dance 12 16 page 13

**Step II:** dance clap story final 28 welcome 25 12 16 page 13 15

**Step III:** final dance clap story 28 welcome 12 16 page 13 15 27

**Step IV:** page final dance clap story 28 welcome 16 13 15 27 18

**Step V:** story page final dance clap 28 welcome 13 15 27 18 22

**Step VI:** welcome story page final dance clap 13 15 27 18 22 34

131. Ans. A.

According to the clues, we get

>Q> M> P; C, P> D and > N

Merging the clues, we get

C > Q > M > P > D > N

132. Ans. C.

C is heavier than Q. So, C is 110 kg.

133. Ans. A.

As no weights are given. So, it can't be determined.

134. Ans. C.

N may be of 68 kilogram in weight

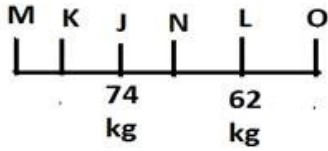

135. Ans. E.

More than three persons are heavier than L

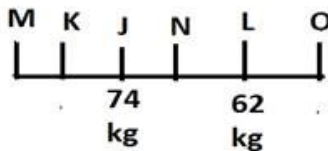

136. Ans. C.

Words and codes are

word	code	word	code
we	ca	player	ka
are	na	more	pa
best	sa	own	qa/ra
friends	ta	aim	ra/qa
good	ba		

The code for 'more' is - pa

137. Ans. A.

Words and codes are

word	code	word	code
we	ca	player	ka
are	na	more	pa
best	sa	own	qa/ra
friends	ta	aim	ra/qa
good	ba		

The code for 'friends' is - ta

138. Ans. B.

Words and codes are

word	code	word	code
we	ca	player	ka
are	na	more	pa
best	sa	own	qa/ra
friends	ta	aim	ra/qa
good	ba		

The code for 'best friends' is - sa ta

139. Ans. E.

Words and codes are

word	code	word	code
we	ca	player	ka
are	na	more	pa
best	sa	own	qa/ra
friends	ta	aim	ra/qa
good	ba		

'ba na ka ra' represent 'own are good player'

140. Ans. A.

Words and codes are

word	code	word	code
we	ca	player	ka
are	na	more	pa
best	sa	own	qa/ra
friends	ta	aim	ra/qa
good	ba		

The code for 'we' is - ca

141. Ans. C.

**NACH stands for** - National Automated Clearing House

National Payments Corporation of India (NPCI) has implemented "National Automated Clearing House (NACH)" for banks, financial institutions, corporates and the Government. NACH is a web based solution to facilitate interbank, high volume, electronic transactions which are repetitive and periodic in nature.

NACH System can be used for making bulk transactions towards distribution of subsidies, dividends, interest, salary, pension etc. and also towards collection of payments pertaining to telephone, electricity, water, loans, investments in mutual funds, insurance premium etc.

142. Ans. C.

**"Wings of Fire"** is an autobiography of **APJ Abdul Kalam**. It was written by **Dr. Kalam** and **Arun Tiwari**.

**Note:** It is the story of a boy from a humble background who went on to become a key player in Indian space research/Indian missile programs and later became the president of India.

143. Ans. C.

The International Development Association (IDA) is a member of the World Bank Group and is headquartered in Washington, D.C. United States.



**Note:** The International Development Association (IDA) is an international financial institution which offers concessional loans and grants to the world's poorest developing countries.

144. Ans. B.

Under MUDRA Bank's Shishu Scheme, maximum loan amount that can be granted is Rs. 50000. The maximum loan amount is Rs. 5 lakh under Kishor Scheme and Rs. 10 lakh under Tarun Scheme.

145. Ans. C.

There is a wide gender disparity in the literacy rate in India: effective literacy rates (age 7 and above) in 2011 were 82.14% for men and 65.46% for women.

Hence, option C is correct.

146. Ans. B.

MCLR stands for Marginal Cost of Funds based Lending Rate. It replaced the earlier existing Base rate system.

147. Ans. B.

Cash Reserve Ratio (CRR) and Statutory Liquidity Ratio (SLR) are deposited in Cash & Liquidity form respectively.

CRR has to be maintained in cash while SLR can be maintained either in cash or in assets that RBI suggests.

Both CRR and SLR are instruments in the hands of RBI to regulate money supply in the hands of banks that they can pump in economy SLR restricts the bank's leverage in pumping more money into the economy.

On the other hand, CRR, or cash reserve ratio, is the portion of deposits that the banks have to maintain with the Central Bank to reduce liquidity in the economy.

148. Ans. D.

Neeraj Chopra is an Indian track and field athlete competing in the javelin throw. He is the second Indian after **Anju Bobby George** to win a World Championship-level gold medal in athletics.

149. Ans. B.

**Federal Reserve** (Fed) is the central banking system of the **United States**. It was created on **December 23, 1913** with the enactment of the Federal Reserve Act, largely in response to a series of financial panics, particularly a severe panic in 1907.

150. Ans. D.

The headquarter of Bank of India is in **Mumbai, Maharashtra**.

151. Ans. A.

FICCI to fund construction of 250 toilets in govt schools in AP.

152. Ans. D.

The Gangetic River Dolphin or South Asian river dolphin is a freshwater dolphin found primarily found in the Ganga and Brahmaputra river. It is an endangered mammal. Once found in abundance, the current population of Sisu in Assam is less than 300.

153. Ans. B.

The extended date for BASEL III Norms was 31st March, 2019. It was earlier 31st March 2018.

154. Ans. B.

*Himachal Pradesh Cricket Association Stadium*, abbreviated as the HPCA Stadium, is a picturesque cricket stadium located in the city of *Dharamshala District Kangra in Himachal Pradesh, India*.

155. Ans. D.

Umaid Bhawan Palace is located at Jodhpur in Rajasthan.

156. Ans. D.

Lokpriya Gopinath Bordoloi International Airport is situated in the city of Guwahati in the state of Assam.

Gopinath Bordoloi was the Chief Minister of Assam before independence and later Chief Minister of the Indian state of Assam, and also a leading Indian independence activist.

157. Ans. B.

**RIDF - Rural Infrastructure Development Fund**

The RIDF was set up by the Government in 1995-96 for financing ongoing rural Infrastructure projects.

The Fund is maintained by the National Bank for Agriculture and Rural Development (NABARD). Domestic commercial banks contribute to the Fund to the extent of their shortfall in stipulated priority sector lending to agriculture.

A RIDF includes rural water supply, rural roads and rural electrification whereas rural industry is not involved in it.

158. Ans. A.

The **Karachi Stock Exchange 100** Index is a major stock market index which tracks the performance of largest companies by market capitalization from each sector of Pakistani economy listed on The Karachi Stock Exchange.

159. Ans. C.

National **Automated** Clearing House (NACH). NACH is a web-based platform to facilitate interbank, high volume, electronic transactions for Banks, Financial Institutions, Corporates and Government. It basically functions like an electronic clearing service available especially for banks.

NACH was launched by the National Payment Corporation of India (NPCI). It is very useful to clear bulk and repetitive transactions that take place among banks.

160. Ans. A.

DICGC stands for - **Deposit Insurance and Credit Guarantee Corporation of India.**

Under DICGC (Deposit Insurance and Credit Guarantee Corporation of India), each depositor is insured up to a maximum amount of Rs 1, 00,000 for both principal and interest.

All commercial banks including foreign banks functioning in India, local area banks and Regional rural banks are insured by DICGC.

161. Ans. B.

**Phnom Penh** is the capital and **Riel** is the currency of **Cambodia**.

**Note:-** Cambodia is a country located in the southern portion of the Indochina Peninsula in Southeast Asia.

162. Ans. A.

The iconic Barabati Stadium is an Indian sports stadium located in Cuttack, Odisha. It is a regular venue for international cricket and is the home ground of Odisha cricket team.

163. Ans. B.

Lok Nayak Jayaprakash Airport also known as Jaiprakash Narayan Airport, Patna is an airport located 5 kilometres (2.7 NM) southwest of Patna, the capital of the state of **Bihar** in India.

164. Ans. D.

**Jakarta** is the capital and Rupiah is the currency of **Indonesia**.

**Note:-** Indonesia is a country in **Southeast Asia** situated between the **Indian** and **Pacific oceans**. It is the **world's largest** island country, with more than **thirteen thousand** islands.

165. Ans. A.

Explanation: The Asian Infrastructure Investment Bank (AIIB) is a multilateral development bank (MDB) conceived for the 21st century. The Bank's foundation is built on the lessons of experience of existing MDBs and the private sector. Its modus operandi will be lean, clean and green: it is situated in Beijing, China.

166. Ans. B.

International Justice Day is celebrated throughout the world on July 17 as part of an effort to recognize the emerging system of international criminal justice.

167. Ans. C.

The **Chinnar Wildlife Sanctuary** is located at **Munnar** in the Idukki district of **Kerala**. The area is diverse in eco systems and rich in ethnic cultural heritage.

**Note:-**It is a **well-known** repository of medicinal plants and the habitat for the endangered Giant Grizzled Squirrel of India.

168. Ans. E.

Headquarter of United Bank of India is located in Kolkata, West Bengal.

169. Ans. C.

**Radha Mohan Singh** was president of BJP's Bihar State unit from 2006 to 2009. He was elected to 11th *Lok Sabha*, 13th *Lok Sabha*, 15th *Lok Sabha* and is currently a member of the 16th *Lok Sabha*.

**He represents Purvi Champaran constituency in Bihar state.**

170. Ans. D.

Asset Reconstruction Company (India) Limited, an asset reconstruction company, offers services for the resolution of non-performing assets upon acquisition from banks and financial institutions in India. It also offers outsourced business services, such as valuation, legal and technical due diligence, documentation relating to transfer of debt, preparation of resolution strategies, preparation of feasibility/market studies, implementation of resolution strategy and monitoring, identification of strategic investors/buyers for business, enforcement/sale of underlying securities, raising of additional funds for borrowers, integration and maintenance of loan accounts of the borrower, protection.

171. Ans. C.

**The Pradhan Mantri Fasal Bima (PMFBY) Yojna** was launched on 18th February 2016 by Prime Minister Shri Narendra Modi.

PMFBY provides a comprehensive insurance cover against failure of the crop thus helping in stabilising the income of the farmers.

The Scheme covers all Food & Oilseeds crops and Annual Commercial/Horticultural Crops for which past yield data is available and for which requisite number of Crop Cutting Experiments (CCEs) are conducted being under General Crop Estimation Survey (GCES).

172. Ans. D.

In terms of the provisions of the RBI Act 1934, notes in denominations higher than **Rs 10000 cannot be issued**.

As per the Coinage Act, 1906, coins can be issued up to the denomination of Rs 1,000.

Banknotes or currency notes currently issued in India are in the denomination of Rs 10, Rs 20, Rs 50, Rs 100, Rs 500, and Rs 2000.

The banknotes are issued by the Reserve Bank of India (Reserve Bank). Small currency notes of Rs 2 and Rs 5 denominations has been discontinued.

But the existing Rs 2 and Rs 5 notes continue to be legal tender and are in circulation. Though Rs 1 note is coinised, the Central Government has recently reintroduced this note.

173. Ans. B.

SEBI has launched a centralized web based complaints redress system (SCORES). This would enable investors to lodge and follow up their complaints and track the status of redressal of such complaints from anywhere. This would also enable the market inter medianes and listed companies to receive the complaints from investors against them, redress such complaints and report redressal.

174. Ans. A.

'Shekel' is the currency of Israel.

**Note:** Israel is a country in the Middle East, on the southeastern shore of the Mediterranean Sea and the northern shore of the Red Sea.

175. Ans. D.

With a total capacity of 1400 MW, Tarapur is the largest nuclear power station in India. The facility is operated by the NPCIL (Nuclear Power Corporation of India). Other nuclear power stations in India are in: Kaiga, Kakrapar, Kudankulam, Madras (Kalpakkam), Narora, Rajasthan, Tarapur.

176. Ans. D.

Valmiki national park is located in the West Champaran district of **Bihar**, India.

177. Ans. C.

World Hepatitis Day observed on **July 28 every** year aims to raise global awareness of hepatitis and encourage prevention, diagnosis and treatment.

178. Ans. C.

**Pinarayi Vijayan** is an Indian politician and the **current Chief Minister** of **Kerala**, in office since 25 May 2016.

179. Ans. D.

Ahmedabad city is situated on the bank of Sabarmati river in Gujarat.

180. Ans. B.

IFSC is an 11- alphanumeric code with the **first four** alphabetic characters representing the **bank name**, and the **last six characters** (usually numeric, but can be alphabetic) representing the

branch. The fifth character is 0 (zero) and reserved for future use. Bank IFS Code is used by the NEFT & RTGS systems to route the messages to the destination banks/branches.

181. Ans. A.

**Wular Lake** is one of the largest **freshwater lakes** in Asia and is in Bandipora district in the Indian state of Jammu and Kashmir.

Wular lake is the largest lake in India.

Chilka is the largest Saline lake in India.

182. Ans. A.

Mount Everest is the Earth's highest mountains with a peak at 8848 m (29,029 ft) above sea level and the 5th tallest mountain measured from the centre of the Earth.

It is located in the Mahalangur section of the Himalayas. The international border between China and Nepal runs across the precise summit point.

183. Ans. C.

**Ans. C**

**The World Health Organization** is a specialized agency of the United Nations (UN) that is concerned with international public health. It was established on **7 April 1948**, headquartered in **Geneva, Switzerland**. The WHO is a member of the United Nations Development Group.

184. Ans. E.

The ECGC was known as -Export Credit Guarantee Corporation of India Ltd) is a company wholly owned by the Government of India based in Mumbai, Maharashtra.

It provides export credit insurance support to Indian exporters and is controlled by the Ministry of Commerce.

185. Ans. D.

**Nairobi** is Kenya's capital city.

The currency of Kenya is the **Shilling**.

The country is named after Mt. Kenya, which is the highest point in the country and is 17,057 feet high.

186. Ans. C.

The Gobi Desert is the largest desert in Asia, covering 500,000 square miles. Extending from northern China into Mongolia, the Gobi Desert receives an average of 7 inches of rainfall each year because the Himalaya mountains block rain clouds from reaching the region.

187. Ans. C.

Payment banks are allowed to accept demand deposits and issue debit cards and can also distribute non risk sharing financial products like mutual funds and insurance products but prohibited from giving loans and issuing credit cards.

188. Ans. C.

It is a strategic port **in Iran which will give India a sea-land access to Afghanistan bypassing Pakistan** and will firm up India's trade relations beyond Afghanistan to countries of Central Asia and St Petersburg in Russia, by linking with North-South Transit Corridor, and the rail networks of Iran and more than a dozen other countries. The travel time for goods all the way to northern Europe from India via Chabahar is expected to be reduced by about half from the current 45 days. The shortened time can permit the movement of certain categories of perishables to and from countries nearer on the route - Iran and Afghanistan.

189. Ans. C.

The Centre has decided to set up a small nuclear plant in Meghalaya. The proposed plant would use the locally available Uranium as fuel as state has almost 16% of country's total uranium deposits.

190. Ans. A.

On 12<sup>th</sup> August 2008, Kerala has become the first Indian state to reserve a government job for HIV positive candidates.

The Kerala State AIDS Control Society (KSACS) has invited applications from the graduate candidates suffering from the disease for the post of coordinator with the organization.

\*\*\*

Prepp



# Latest Sarkari jobs, Govt Exam alerts, Results and Vacancies

- ▶ Latest News and Notification
- ▶ Exam Paper Analysis
- ▶ Topic-wise weightage
- ▶ Previous Year Papers with Answer Key
- ▶ Preparation Strategy & Subject-wise Books

To know more [Click Here](#)



[www.prepp.in](http://www.prepp.in)